

TOSCA D61 - TOSCA SLIM D63 - TOSCA LIGHT D64

COLORI STANDARD - STANDARD COLORS

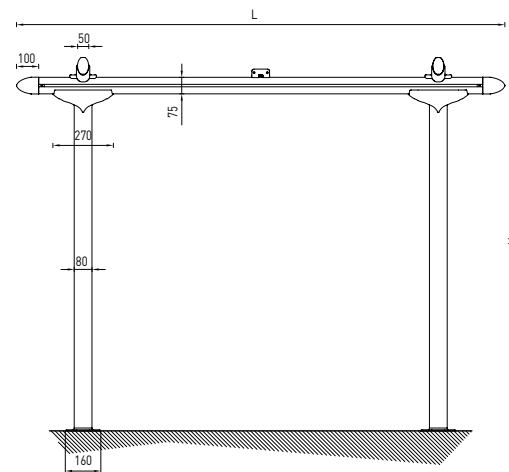

TOSCA D61



Vista frontale
Frontal view

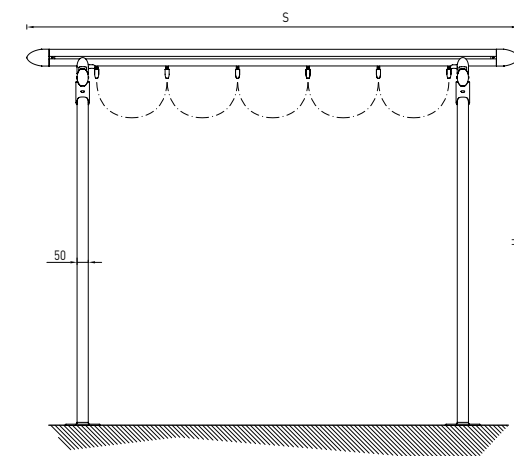

Vista laterale
Lateral view

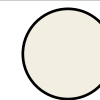

9010

TOSCA SLIM D63

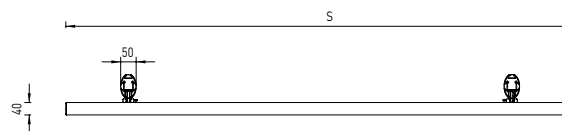

40

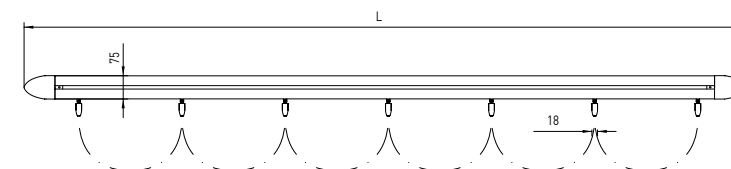

TOSCA LIGHT D64

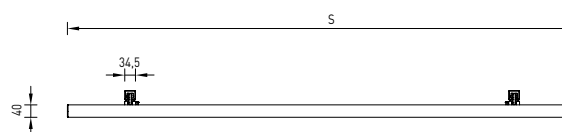

40

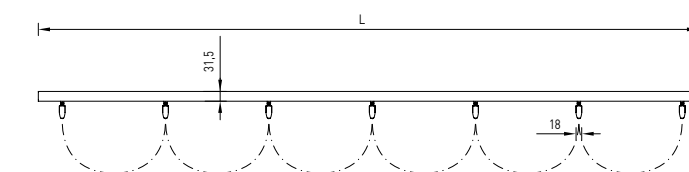



Vista frontale
Frontal view

Vista laterale
Lateral view

L= larghezza
width
S= sporgenza
projection

 Strutture per la copertura di terrazzi o aree di giardino.
Resistenza al vento garantita fino alla classe 2 secondo la UNI EN 13561.

 Structures for terraces or garden
Wind resistance guarantee up to class 2 according UNI EN 13561

 "Strukturen zur Abdeckung von Terrassen oder Grünflächen.
Windbeständigkeit garantiert bis Klasse 2 nach EN 13561."

 Strutture per la copertura di terrazzi o aree di giardino.
Resistenza al vento garantita fino alla classe 2 secondo la UNI EN 13561.

 Estructura para la cobertura de la terraza o zonas de jardín.
Resistencia al viento garantizada hasta la clase 2 según la UNE EN 13561.