 Struttura ombreggiante in alluminio con tenda richiudibile ad impacchettamento, formata da un telo (teso quando aperta) fissato ad un sistema di traversi, carrelli e guide che ne permettono lo scorrimento orizzontale. Resistenza al vento garantita fino alla classe 3 secondo la UNI EN 13561. Su richiesta è possibile installare il sistema antigoccia per la protezione dalla pioggia. Non si garantisce la tenuta al carico di neve.

La formazione di condensa sul telo non è da considerarsi difetto, si tratta di un fenomeno naturale.

C Tettuccio copritenda
B Comando di movimentazione elettrico
I Traversa supporto motore
O Guida di scorrimento
F Trave frontale
E Pilastro
N Traversa supporto tettuccio

 Aluminium shady structure with packaging retractable awning, in fabric made (tight when opened) fixed to crossbar profiles, trolleys and guides system which permit the horizontal sliding. Guaranteed wind resistance up to class 3 according to UNI EN 13561. On request it is possible to install the antidrop system for the rain protection. The resistance under snow weight is not guaranteed.

The development of condensation on the fabric is natural and not to be considered as a defect.

C Protection hood
B Moving electrical control
I Supporting motor crossbar profile
O Sliding guide
F Frontal girder
E Pilar
N Supporting hood crossbar profile

 Eine Sonnenschutzstruktur aus Aluminium mit einer Markise, bei der sich das Tuch (gespannt wenn die Markise herausgefahren ist) durch Einfalten schließt. Diese ist in einem System aus Querträgern, Laufkatzen und Führungsschienen bestehend sodass ein waagerechtes Laufen möglich ist, befestigt. Windbeständigkeit: Nach UNI EN 13561 bis Klasse 3 garantiert. Auf Anfrage ist es möglich ein Abdichtungskeder für Regenschutz zu installieren. Eine Schneelastbeständigkeit wird nicht garantiert.

Die Entwicklung von Kondensation auf den Stoff ist nicht ein Defekt, sondern ist natürlich.

C Schutzdach der Markise
B Elektrische Bedienung
I Querträgerbalken für den Motor
O Laufschiene
F Frontbalken
E Pfosten
N Querträgerbalken für das Schutzdach

 Structure pergola en aluminium avec toile rétractable par empaquetement. Formée d'une toile (tendue une fois ouverte) reliée à un système composé de traverses, de chariots, et de coulisses qui permettent un déplacement horizontal de la toile. Résistance au vent garantie jusqu'à la classe 3 selon la norme UNI 13561. Sur demande, il est possible d'intégrer le système antigoutte pour une protection de la pluie. Aucune garantie pour la tenue à la neige.

Le développement de condensation sur le tissu n'est pas considéré un défaut, c'est un phénomène naturel.

C Auvent de protection
B Commande pour le manoeuvre électrique
I Profil de traverse support moteur
O Glissière pour le glissement
F Poutre frontale
E Pilier
N Profil de traverse support auvent

 Estructura sombreada de aluminio con toldo que se puede empaquear, hecho por un tejido (tendido cuando abierto) fijado a un sistema de perfiles transversales, carritos y guías que permiten el movimiento horizontal. Resistencia al viento garantizada hasta la clase 3 según la UNI EN 13561. A petición es posible colocar el sistema antigota para la protección de la lluvia. No se garantiza la resistencia bajo el peso de la nieve.

La formación de agua de condensación no es un defecto sino un fenómeno natural.

C Tejadillo cubretoldo
B Mando de movimiento eléctrico
I Perfil transversal soporte motor
O Guía de desplazamiento
F Viga frontal
E Pie
N Perfil transversal soporte tejadillo



Schema tecnico generale/General technical plan/Allgemein-technisches Schema/Plan technique général/Dibujo tecnico general

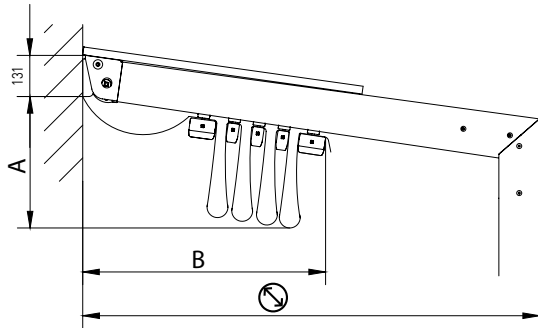

Larghezza interasse guide/Guides interaxis width/Breite des Achsabstandes der Führungsschienen/Largeur entraxe coulisser/Linea guía intereje

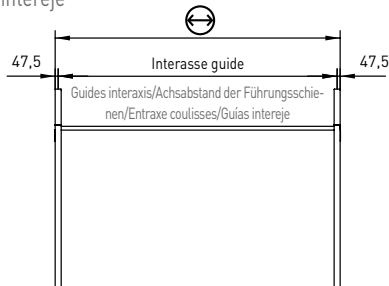

Dimensioni profili/Profiles dimensions/Profilabmessungen/Mesures profils/Dimensiones perfiles

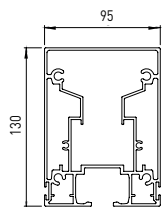

Guida
Guide
Führungsschiene
Glissière
Guía

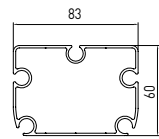

Terminale
Terminal bar profile
Fallstange
Barre de charge
Terminal

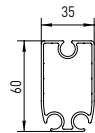

Traverso Porta Tessuto
Fabric carrying Crossbar profile
Stoffquerträger
Profil de traverse porte tissu
Palillo



Sezione travi/Girder section/Balkenquerschnitt/Section poutres/Sección viga

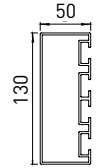

Profilo supporto guida
Guide support profile
Tragprofil für Führungsschiene
Profil support coulisse
Perfil soporte guía

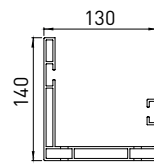

Grondaia Fissa
Fixed Gutter
Fixe Rinne
Gouttiere Fixe
Canalón Fijo

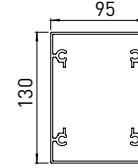

Pilastro
Pilar
Profil
Pilier
Pie



Attacchi a terra
Ground connections
Bodenbefestigungen
Fixations au sol
Fijaciones a suelo

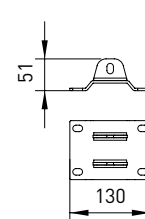
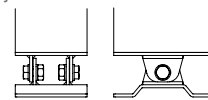

Applicazione a soffitto
Ceiling installation
Deckenmontage
Pose au plafond
Instalación a techo

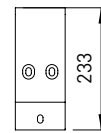
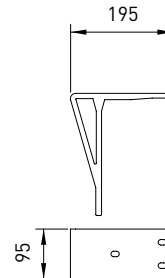
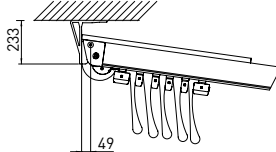

Applicazione a parete
Wall installation
Wandmontage
Pose au mur
Instalación a pared

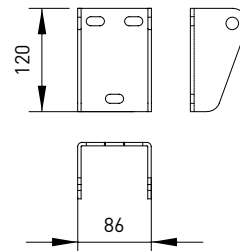
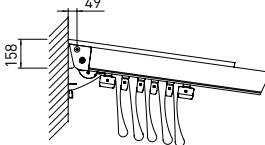

Per tabelle pendenze vedi pag. 172/175 - For slope tables please see page 172/175 - Für Neigungstabellen siehe S. 172/175 - Pour les tableaux des différences de niveau, voir p. 172/175 - Para las tablas de inclinación véase pág. 172/175

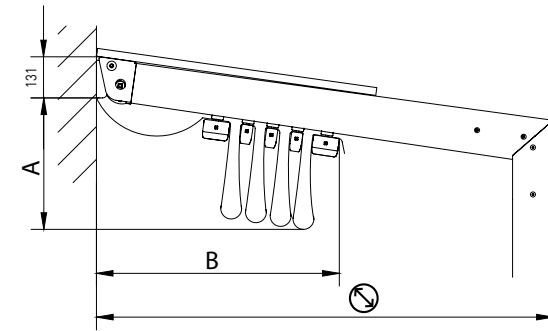

Valori indicativi degli ingombri del telo e del numero di traversi portatelo. Attenzione: i valori esposti possono variare a seconda della pendenza.

Indicative values of the fabric encumbrance and the number of the fabric carrying crossbar profiles. Attention: the indicated values may change according to the inclination.

Richtwerte der Ausmaße des Tuches und der Anzahl der Stoffquerträger Achtung: die angegebenen Werte können sich je nach Gefälle ändern.

Valeurs indicatives des encombrements de la toile et du nombre de profils de traverse porte tissu. Attention: les valeurs peuvent changer selon la pente

Valores indicativos de las dimensiones del tejido y del número de palillos. Atención: los valores indicados pueden cambiar según la inclinación.

| | A cm | B cm | N |
|-----|---------|---------|------|
| 250 | 39 | 50 | 5 |
| 300 | 40 | 55 | 5 |
| 350 | 41 | 60 | 6 |
| 400 | 42 | 66 | 7 |
| 450 | 43 | 71 | 8/10 |
| 500 | 44 | 71 | 9/13 |
| 550 | 44 | 76 | 10 |
| 600 | 45 | 81 | 10 |
| 650 | 46 | 86 | 11 |

N Numero traversi (compreso terminali). Misura massima interasse traversi portatelo 58 cm.

N Crossbar profile numbers (terminals included). Maximum interaxis fabric carrying cross bar profiles measure cm 58.

N Anzahl der Querträger (inklusive Fallstangen). Maximaler Achsabstand der Stofftragerschienen cm 58.

N Nombre profils de traverse (compris barres de charge). Mesure maximale entraxe profils traverse porte tissu cm 58.

N Numero de perfiles transversales (terminales incluidos). Medida máxima intereje perfiles transversales para lona cm 58.